

环保物料

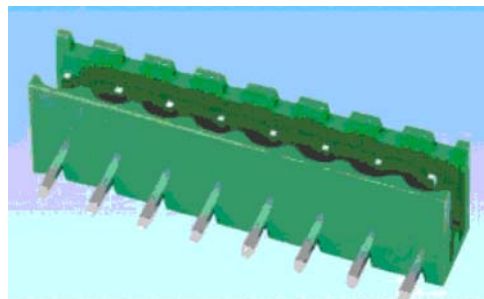

产品型号	MODEL	KD2EDGR-X	
材质&电镀	MATERIAL&PLATING		
螺丝	Screw	-	
弹片	Reed	-	
焊针	Pin header	黄铜, 镀锡 Brass, Tin plated	
塑件	Housing	PA66, UL94V-0	
电气性能	ELECTRICAL	UL	IEC
额定电压	Rated voltage	300V	320V
额定电流	Rated current	15A	20A
接触电阻	Contact resistance	20mΩ	
绝缘电阻	Insulation resistance	500MΩ/1000V	
耐电压	Withstanding voltage	AC2000V/1min	
使用线径	Wire range	-	
机械性能	MECHANICAL		
温度范围	Temp. range	-40℃~+105℃	
瞬时温度	Max. soldering	+250℃, 5sec	
扭矩	Torque	-	
剥线长度	Strip length	-	

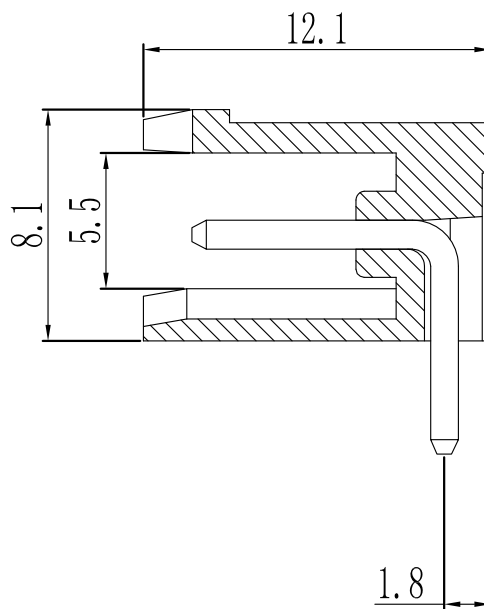
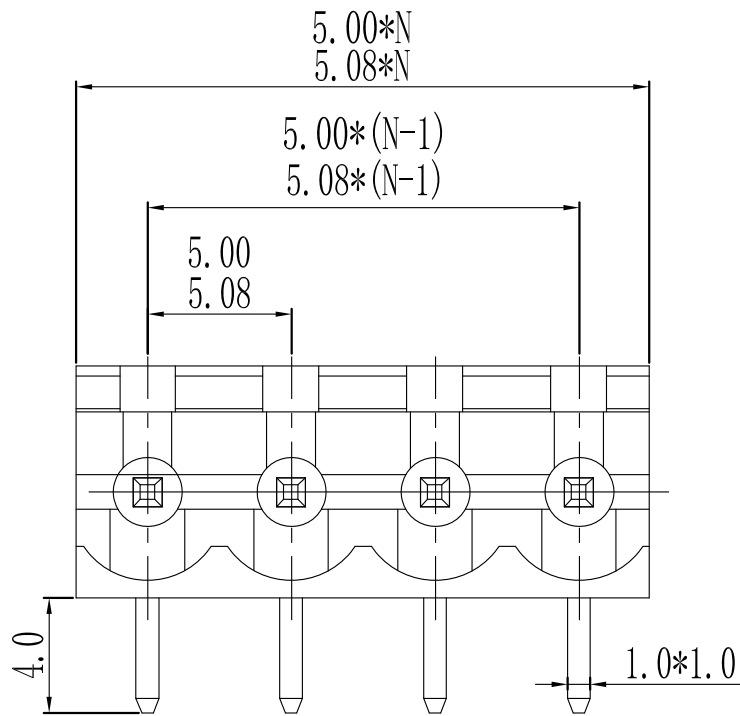

N=Number of Contacts

				GENERAL TOLERANCES		SCALE: 1:1	NAME	DATE	康导新能源 网址: www.dgconne.com 电话: 0769-85337633 邮箱: 2850175986@qq.com 传真: 0769-85392827	PART. NO: KDTB0100
				LINEAR	ANGLES	APPROVED	黎腾	2017.06.16		DWG. NO:
A0	新图面发行	2017.06.16	UNIT: MM	0.00±0.25	X° ±3°	DESIGNER	肖坤权	2017.06.16	TITLE: Pitch5.00/5.08mm Pluggable Terminal Blocks	REV: A0
REV.	REVISION RECORD	DATE	SIZE: A4	0.000±0.15	X° X'±2°	DRAWN	旷淇	2017.06.16		SHEET: 1/1