

# 环保物料

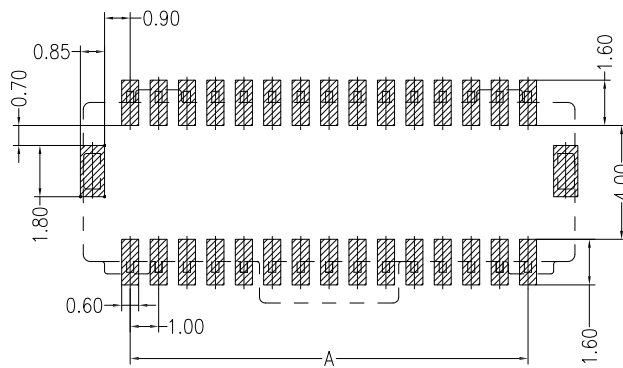
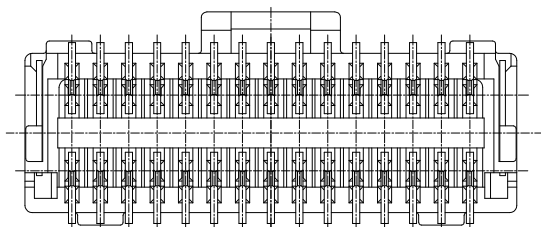
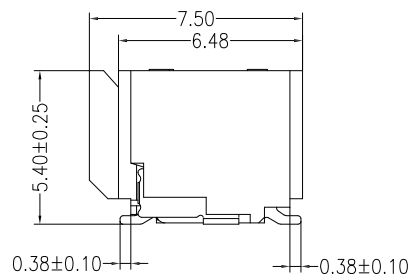
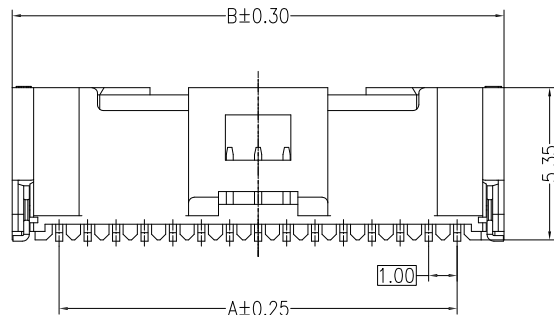
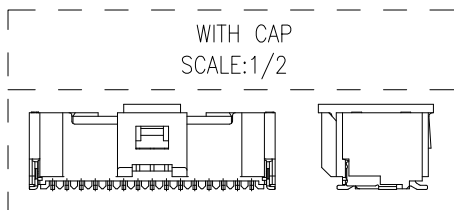
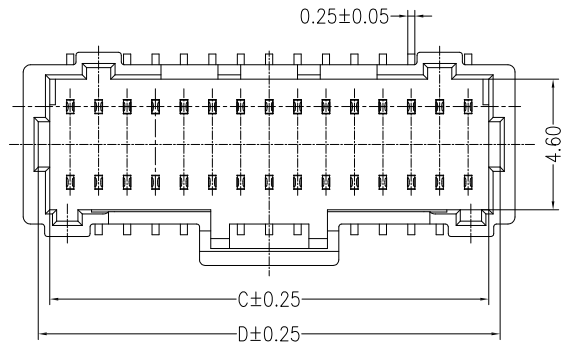

PCB LAYOUT(Tolerance:±0.05)

## Specifications:

- Poles: 30 to 50
- Contact resistance:  $\leq 20m\Omega$
- Insulation resistance:  $\geq 100M\Omega$
- Rated voltage: 50V AC DC
- Rated current: 0.8A AC DC
- Withstand Voltage: 250V AC/minute
- Temperature Range:  $-25^{\circ}C \sim +85^{\circ}C$
- Housing: PA6T UL94V-0, Natural
- Contacts: Phosphor Bronze/ Gold-plated
- Solder tabs: Brass/MATTE Sn-plated
- Cap: PA6T UL94V-0, Natural

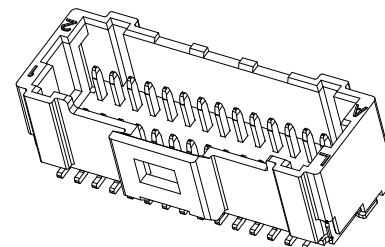

| PIN.  | DIM A | DIM B | DIM C | DIM D |
|-------|-------|-------|-------|-------|
| 2x10P | 9.00  | 12.30 | 10.45 | 11.25 |
| 2x15P | 14.00 | 17.30 | 15.45 | 16.25 |
| 2x20P | 19.00 | 22.30 | 20.45 | 21.25 |
| 2x25P | 24.00 | 27.30 | 25.45 | 26.25 |

|      |                 |  |            |                    |            |            |          |            |   |                    |                       |  |
|------|-----------------|--|------------|--------------------|------------|------------|----------|------------|---|--------------------|-----------------------|--|
|      |                 |  |            | GENERAL TOLERANCES |            | SCALE: 1:1 | NAME     | DATE       |  <b>康导新能源</b><br>网址: www.dgonne.com 电话: 0769-85337633<br>邮箱: 2850176986@qq.com 传真: 0769-85392827 |                    | PART. NO:<br>21008AWV |  |
|      |                 |  |            | LINEAR             | ANGLES     | APPROVED   | 黎腾       | 2017.06.16 |   |                    | DWG. NO:              |  |
| A0   | 新图面发行           |  | 2017.06.16 | UNIT: MM           | 0.00±0.25  | X° REF±6°  | DESIGNER | 肖坤权        | 2017.06.16  | REV: A0 SHEET: 1/1 |                       |  |
| REV. | REVISION RECORD |  | DATE       | SIZE: A4           | 0.000±0.15 | X° X'±2°   | DRAWN    | 旷淇         | 2017.06.16  |                    |                       |  |